

SERIES/SECTION	SECTION NO.	FORM NO.
6 POWER TRAIN		
Transmission Maintenance and Troubleshooting	6002	8-41280
Transmission Diagrams and Operation	6003	8-41280
Charging Pump	6005	9-67861
Transmission Control Valve	6007	8-41280
Torque Converter	6010	8-41280
Transmission	6016	8-41280
Final Drives	6017	8-41280
Transmission Controls	6018	8-41280
Drive Shaft	6021	8-41280
7 BRAKES		
Brakes	7001	8-41280
8 HYDRAULICS		
Hydraulic System Specifications, Diagrams, Maintenance Troubleshooting, and Pressure Checks	8002	8-41280
Cleaning the Hydraulic System	8003	8-41280
Pump	8005	8-41280
Equipment Control Valve	8007	8-41280
Selector Valve	8021	8-41280
Cylinders	8090	8-41280
9 MOUNTED EQUIPMENT		
Air Conditioning Troubleshooting	9002	8-41280
Air Conditioning System	9003	8-41280
Loader	9010	8-41280
Dozer Blade	9020	8-41280
Ripper	9031	8-41280
Cab and Canopy	9061	8-41280
Operators Seats and Seat Belts	9064	8-41280
Decals, Painting, and Noise Control	9201	8-41280
Winch	9300	8-41280

1001

SAFETY RULES SERVICE MANUAL INTRODUCTION AND TORQUE SPECIFICATIONS

TABLE OF CONTENTS

Safety Rules	1001-2	Illustrations and Photos	1001-4
Service Manual Introduction	1001-4	Clear and Simple English	1001-4
Right, Left, Front, and Rear	1001-4	Special Tools	1001-4
Text	1001-4	Product Identification Number (PIN) and Serial Numbers	1001-5
Table of Contents	1001-4	Torque Specifications	1001-6
Page Numbers	1001-4		

Written In *Clear
And
Simple
English*

SAFETY RULES

 This symbol means **ATTENTION! BECOME ALERT! YOUR SAFETY IS INVOLVED.** The message that follows the symbol contains important information about safety. Carefully read the message. Make sure you fully understand the causes of possible injury or death. 1-1-C

IMPORTANT: To prevent injury on the job, follow the Warning, Caution, and Danger notes in this section and other sections throughout this manual. Follow the instructions carefully.

The procedures recommended and shown in this manual are good, effective service methods. However, all possible procedures and service hazards may not be covered. Therefore, if you use a tool or procedure not recommended, you must make sure that the method you select is a safe method.

Put the warning tag shown below on the key for the key switch when you are servicing or repairing this machine. One warning tag is on every new machine. You can buy additional warning tags, part number 331-4614, from Service Parts Supply.

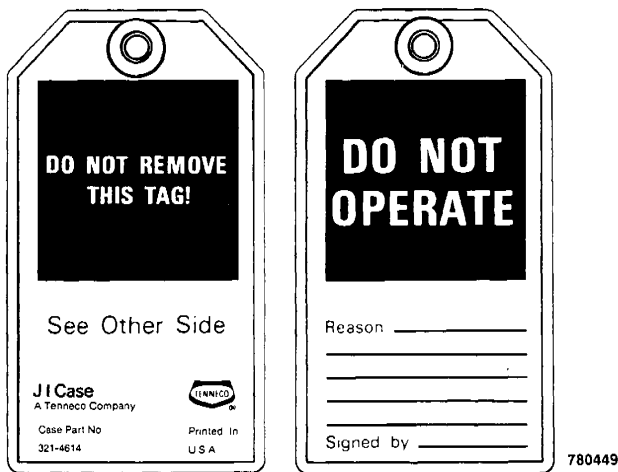

780449

 **WARNING:** Read operator's manual to familiarize yourself with control lever functions. 46-27

 **WARNING:** Operate tractor and equipment controls from the seat position only. Any other method could result in serious injury. 48-55

 **WARNING:** This is a one man machine, no riders allowed. 35-8

 **WARNING:** If you wear clothing that is too loose or do not use the correct safety equipment for your job, you can be injured. Always wear clothing that will not catch on objects. Extra safety equipment that can be required includes hard hat, safety shoes, ear protection, eye or face protection, heavy gloves and reflector clothing. 45-3-A

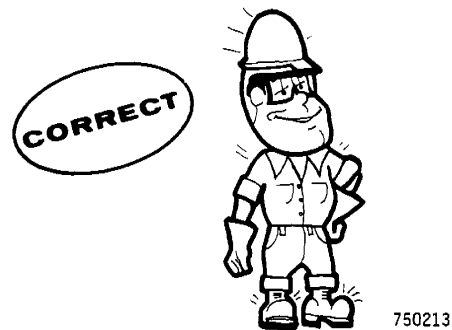

750213

 **DANGER:** Engine exhaust fumes can cause death. If it is necessary to start the engine in a closed place, remove the exhaust fumes from the area with an exhaust pipe extension. If you do not have an exhaust pipe extension, open the doors and get outside air into the area. 48-56

 **WARNING:** Operate controls from the operator's seat only. 35-7

 **WARNING:** When working in the area of the fan belt with the engine running, avoid loose clothing if possible, and use extreme caution. 35-4



WARNING: Whenever the bucket must be raised to aid in servicing, block the loader arms in place with lift cylinder support strut or a suitable safety stand.

23-7-B

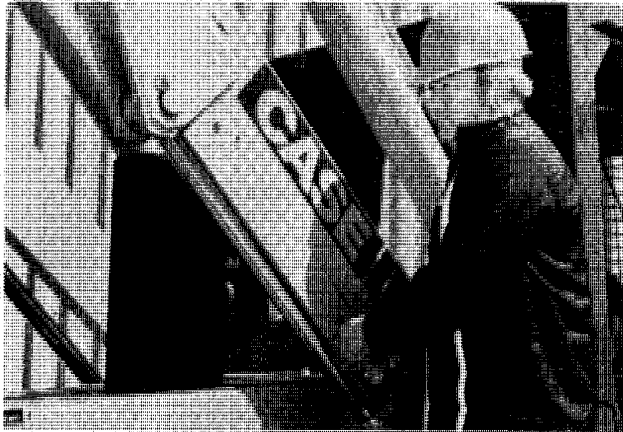

835495



WARNING: When doing checks and tests on the equipment hydraulics, follow the procedures as they are written. **DO NOT** change the procedure. 47-44



WARNING: When putting the hydraulic cylinders on this machine through the necessary cycles to check operation or to remove air from a circuit, make sure all people are out of the way. 47-45



WARNING: Use insulated gloves or mittens when working with hot parts.

47-41A



CAUTION: Pin sized and smaller streams of hydraulic oil under pressure can penetrate the skin and result in serious infection. If hydraulic oil under pressure does penetrate the skin, seek medical treatment immediately. Maintain all hoses and tubes in good condition. Make sure all connections are tight. Make a replacement of any tube or hose that is damaged or thought to be damaged. **DO NOT** use your hand to check for leaks; use a piece of cardboard or wood. 40-6-A



CAUTION: When removing hardened pins such as a pivot pin, or a hardened shaft, use a soft head (brass or bronze) hammer or use a driver made from brass or bronze and a steel head hammer. 46-17



CAUTION: When using a hammer to remove and install pivot pins or separate parts, using compressed air or using a grinder, wear eye protection that completely encloses the eyes (approved goggles or other approved eye protectors). 46-13



CAUTION: When servicing or repairing the machine, keep the shop floor and operator's compartment and steps free of oil, water, grease, tools, etc. Use an oil absorbing material and/or shop cloths as required. Use safe practices at all times. 40-8



CAUTION: Use suitable floor (service) jacks or chain hoists to raise wheels or track off the floor. Always block machine in place with suitable safety stands. 40-7-A



CAUTION: Some components of this machine are very heavy. Use suitable lifting equipment or additional help as instructed in this service manual. 40-10

SERVICE MANUAL INTRODUCTION

This service manual has been prepared with the latest service information available. Troubleshooting, removal, disassembly, inspection and installation procedures, and complete specifications and tightening references can be found in most sections. Some sections have drawings but no written procedure because the job is so easily done. This service manual is one of the most important tools available to the service technician.

Right, Left, Front, and Rear

The terms right-hand and left-hand and front and rear as used in this manual indicate the right and left sides, and front and rear of the machine as seen from the operator's seat for correct operation of the machine or attachment.

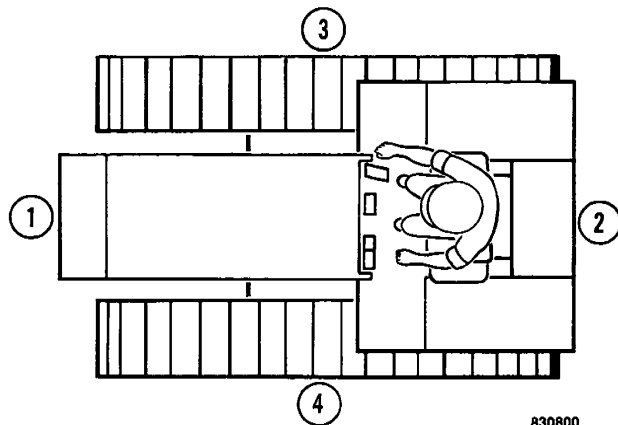

1. Front
2. Rear

3. Right Side
4. Left Side

Text

If the service manual is for more than one machine or different models of components (planetary axles, gear boxes, control valves, etc.) the procedures have the steps necessary to service each model.

Table of Contents

A Table of Contents is in the front of this manual. The Table of Contents shows the main divisions and the sections that are in each division. The individual sections, where necessary, have a Table of Contents on the cover or second page of that section.

Page Numbers

All page numbers are made of two numbers separated by a dash, such as 4002-9. The number before the dash is the section number. The number following the dash is the page number in that section. Page numbers will be found at the upper right or left of each page.

Illustrations and Photos

Illustrations are put as near as possible to the text and are to be used as part of the text. Photos normally are put below the step to which they apply.

Clear and Simple English

This manual is written in C.A.S.E. (Clear and Simple English). C.A.S.E. is easier to read and understand than "regular" English because C.A.S.E. uses a small number of common words and has special rules for writing.

All sections written in C.A.S.E. are indicated by the symbol below.

Written In *Clear
And
Simple
English*

Special Tools

Special tools are needed to remove and install, disassemble and assemble, check, and adjust some component parts of this machine. Some special tools can be easily made locally and the necessary information to make the tool is in this service manual. Other special tools are more difficult to make locally and are available from Service Tools in the U.S. and from Jobborn Manufacturing in Canada. Use these tools according to the instructions in this service manual for your personal safety and to do the job correctly.

Order special tools from either of the following companies:

Service Tools
P.O. Box 314
Owatonna, Minnesota 55060

Jobborn Manufacturing Co.
97 Frid Street
Hamilton, Ontario L8P 4M3
Canada

PRODUCT IDENTIFICATION NUMBER (PIN) AND SERIAL NUMBERS

NOTE: A serial number plate is also on some components such as the starter, alternator, pump, etc.

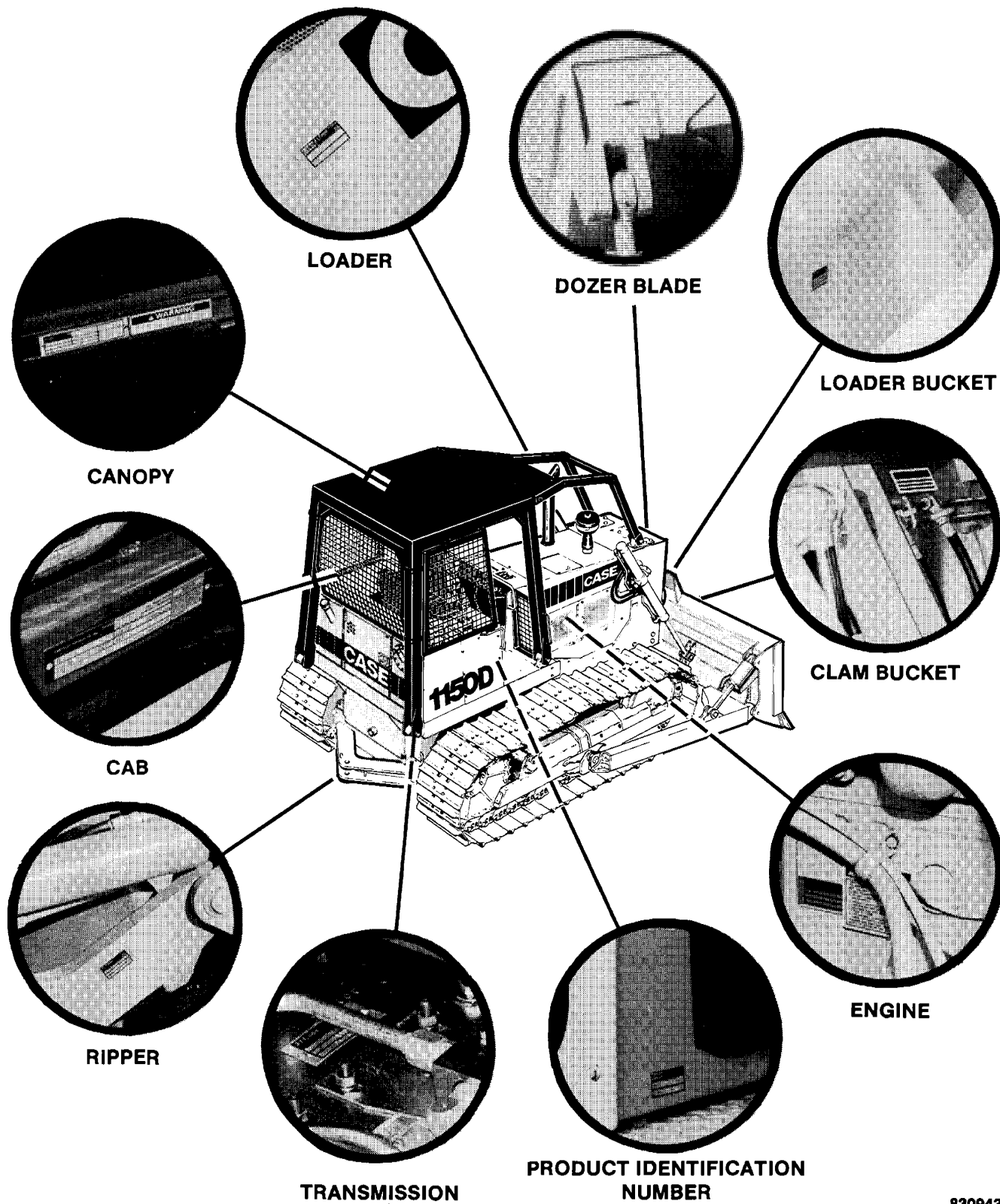

TORQUE SPECIFICATIONS - U.S. HARDWARE

Use the torques in this chart when special torques are not given. These torques apply to fasteners with both UNC and UNF threads as received from suppliers, dry, or when lubricated with engine oil. Not applicable if special graphites, moly-disulfide greases, or other extreme pressure lubricants are used.

Grade 5 Bolts, Nuts, and Studs



Size	Pound-Feet	Newton metres	Kilogram metres
1/4 in 6.4 mm	9-11	12-15	1.2-1.5
5/16 in 7.9 mm	17-21	23-28	2.4-2.9
3/8 in 9.5 mm	35-42	48-57	4.8-5.8
7/16 in 11.1 mm	54-64	73-87	7.5-8.8
1/2 in 12.7 mm	80-96	109-130	11.1-13.3
9/16 in 14.3 mm	110-132	149-179	15.2-18.2
5/8 in 15.9 mm	150-180	203-244	20.8-24.9
3/4 in 19.0 mm	270-324	366-439	37.3-44.8
7/8 in 22.2 mm	400-480	542-651	55.3-66.4
1.0 in 25.4 mm	580-696	787-944	80.2-96.2
1-1/8 in 28.6 mm	800-880	1085-1193	111-122
1-1/4 in 31.8 mm	1120-1240	1519-1681	155-171
1-3/8 in 34.9 mm	1460-1680	1980-2278	202-232
1-1/2 in 38.1 mm	1940-2200	2631-2983	268-304

Grade 8 Bolts, Nuts, and Studs



Size	Pound-Feet	Newton metres	Kilogram metres
1/4 in 6.4 mm	12-15	16-20	1.7-2.1
5/16 in 7.9 mm	24-29	33-39	3.3-4.0
3/8 in 9.5 mm	45-54	61-73	6.2-7.5
7/16 in 11.1 mm	70-84	95-114	9.7-11.6
1/2 in 12.7 mm	110-132	149-179	15.2-18.2
9/16 in 14.3 mm	160-192	217-260	22.1-26.5
5/8 in 15.9 mm	220-264	298-358	30.4-36.5
3/4 in 19.0 mm	380-456	515-618	52.5-63.0
7/8 in 22.2 mm	600-720	814-976	83.0-99.5
1.0 in 25.4 mm	900-1080	1220-1465	124-149
1-1/8 in 28.6 mm	1280-1440	1736-1953	177-199
1-1/4 in 31.8 mm	1820-2000	2468-2712	252-277
1-3/8 in 34.9 mm	2380-2720	3227-3688	329-376
1-1/2 in 38.1 mm	3160-3560	4285-4827	437-492

TORQUE SPECIFICATIONS - STEEL HYDRAULIC FITTINGS

Tube OD Hose ID	Thread Size	Pound- Feet	Newton metres	Kilogram metres
37 Degree Flare Fittings				
1/4 in 6.4 mm	7/16-20	6-12	8-16	0.8-1.7
5/16 in 7.9 mm	1/2-20	8-16	11-21	1.1-2.2
3/8 in 9.5 mm	9/16-18	10-25	14-33	1.4-3.5
1/2 in 12.7 mm	3/4-16	15-42	20-56	2.1-5.8
5/8 in 15.9 mm	7/8-14	25-58	34-78	3.5-8.0
3/4 in 19.0 mm	1-1/16-12	40-80	54-108	5.5-11.1
7/8 in 22.2 mm	1-3/16-12	60-100	81-135	8.3-13.9
1.0 in 25.4 mm	1-5/16-12	75-117	102-158	10.4-16.2
1-1/4 in 31.8 mm	1-5/8-12	125-165	169-223	17.3-22.8
1-1/2 in 38.1 mm	1-7/8-12	210-250	285-338	29.0-34.6

Tube OD Hose ID	Thread Size	Pound- Feet	Newton metres	Kilogram metres
Straight Threads with O-ring				
1/4 in 6.4 mm	7/16-20	12-19	16-25	1.7-2.6
5/16 in 7.9 mm	1/2-20	16-25	22-33	2.2-3.5
3/8 in 9.5 mm	9/16-18	25-40	34-54	3.5-5.5
1/2 in 12.7 mm	3/4-16	42-67	57-90	5.8-9.3
5/8 in 15.9 mm	7/8-14	58-92	79-124	8.0-12.7
3/4 in 19.0 mm	1-1/16-12	80-128	108-174	11.1-17.8
7/8 in 22.2 mm	1-3/16-12	100-160	136-216	13.8-22.1
1.0 in 25.4 mm	1-5/16-12	117-187	159-253	16.2-25.9
1-1/4 in 31.8 mm	1-5/8-12	165-264	224-357	22.8-36.5
1-1/2 in 38.1 mm	1-7/8-12	250-400	339-542	34.6-55.3

Split Flange Mounting Bolts			
Size	Pound- Feet	Newton metres	Kilogram metres
5/16-18	15-20	20-27	2.1-2.8
3/8-16	20-25	26-33	2.8-3.5
7/16-14	35-45	47-61	4.7-6.2
1/2-13	55-65	74-88	7.6-9.0
5/8-11	140-150	190-203	19.4-20.7

1002

MAINTENANCE AND LUBRICATION

TABLE OF CONTENTS

Fluids and Lubricants Chart	1002-2
Maintenance Chart	1002-3

Written In *Clear
And
Simple
English*

FLUIDS AND LUBRICANTS CHART

COMPONENT	CAPACITY		SPECIFICATION
	U.S.	Metric	
Fuel tank	52 gallons	196 litres	See Operators Manual
Engine crankcase			Recommended Engine Oil:
With filter change	27 quarts	25.6 litres	Case HDM Oil or Enginegard™
Without filter change	24 quarts	22.7 litres	Alternate Engine Oil:
			Above 32°F (0°C) SAE 30 CD
			10° to 50°F (-12° to 10°C) .. SAE 20W CD
			Below 32°F (0°C) SAE 10W CD
Hydraulic reservoir	15 gallons	57 litres	Case TCH Fluid or Powergard™ TCH™ Alternate: Type C2 or C3 fluid.
Transmission and torque converter	14 gallons	53 litres	Case TCH Fluid Alternate:
Complete system	15 gallons	57 litres	Type C2 or C3 hydraulic/transmission fluid.
Final drive (Each)	8 quarts	7.6 litres	Case FDL or Loadgard™ GL-5 Alternate lubricant: SAE 85/140 EP (API-GL-5)
Cooling system	13 gallons	49 litres	Mix ethylene glycol with water for the lowest ambient temperature expected. The mixture must be half ethylene glycol and half water.
Batteries	as required		Add drinking water or distilled water.
Grease fittings	as required		No. 2 molydisulfide grease.
Winch refill capacity	12.5 gallons	47 litres	Case TCH Fluid or Powergard™ TCH™ Alternate: Type C2 or C3 fluid.

INTERVAL	SERVICE	INSTRUCTIONS
Every 500 hours of operation.	Clean the fuel sediment bowl and screen at the fuel the fuel injection pump. Replace the first and second stage fuel filters. Replace the oil filter in the winch. Change the oil in the winch. Clean the filter screen in the winch. Replace the oil filter for the transmission. Replace the filter for the hydraulic system. Lubricate the pivot shaft on dozer machines. Lubricate the universal joints and the slip spline. Check the torque for the mounting bolts for the ROPS cab and ROPS canopy.	Operators Manual. Section 3010. Section 9300. Section 9300. Section 9300. Section 6002. Section 8002. Operators Manual. Operators Manual. Section 9061.
Every 1000 hours of operation	Change the oil in each final drive. Change the oil in the transmission. Clean the breathers for the transmission. Clean the filter screen in the suction line for the charging pump of the transmission. Change the oil in the hydraulic reservoir. Clean the filter screen in the hydraulic reservoir. Clean the breather for the hydraulic reservoir. Service the ROPS cab air filter.	Section 6002. Section 6002. Section 6002. Section 6002. Section 8002. Section 8002. Section 8002. Section 9061.
Every 2000 hours of operation or each year whichever occurs first	Flush the cooling system.	Fluids and Lubricants Chart.
As required	Check the sediment bowl at the fuel injection pump for water. Drain water and sediment from the fuel tank. Clean the fuel filler screen. Adjust the deflection of the track. Tighten the bolts for the track shoes. Clean the precleaner bowl when the dust is up to the mark on the side of the bowl.	Operators Manual. Section 3001. Section 3001. Section 5506. Section 5506. Operators Manual.

Section 1010

GENERAL ENGINE SPECIFICATIONS

1150D CRAWLER

504BD DIESEL ENGINE

General

Type	6 Cylinder, 4 Stroke Cycle, Valve-In-Head
Firing Order	1-5-3-6-2-4
Bore	4-5/8 Inches (117.48 mm)
Stroke	5 Inches (127 mm)
Piston Displacement	504 Cubic Inches (8 259 cm ³)
Compression Ratio	17 to 1
No Load Governed Speed	2280 to 2320 RPM
Rated Engine Speed	2100 RPM
Engine Idling Speed	750 to 800 RPM
Exhaust Valve Rotators	Positive Type
Valve Tappet Clearance (Exhaust)	(COLD) 0.025 Inch (0.635 mm)
(Intake)	(COLD) 0.015 Inch (0.381 mm)
Thermostat Operating Range	175°F to 202°F (79°C to 94°C)

Piston And Connecting Rods

Rings Per Piston	3
Number of Compression Rings	2
Number of Oil Rings	1
Type Pins	Full Floating Type
Type Bearing	Replaceable Precision, Steel Back, Copper-Lead Liners

Main Bearings

Number of Bearings	7
Type Bearings	Replaceable Precision, Steel Back, Copper-Lead Liners

Engine Lubricating System

Crankcase Capacity (Without Filter Change)	24 Quarts (14.20 Litres)
(With Filter Change)	27 Quarts (16.09 Litres)
Oil Pressure	45 to 60 PSI (310 to 414 kPa)(3.10 to 4.14 bar)
	With Engine Warm and Operating At Rated Engine Speed
Type System	Pressure And Spray Circulation
Oil Pump	Gear Type
Oil Filter	Full Flow Turn On Type

Fuel System

Fuel Injection Pump	Robert Bosch, Type PES Multiple Plunger
Pump Timing	27 Degrees Before Top Center
Fuel Injectors	17 mm Type, Opening Pressure (New)
	3950 to 4100 PSI (27 235 to 28 270 kPa)
Fuel Transfer Pump	Plunger Type, Integral Part Of Injection Pump
Governor	Variable Speed, Fly-Weight Centrifugal Type, Integral Part Of Injection Pump
1st Stage Fuel Filter	Full Flow Turn On Type
2nd Stage Fuel Filter	Full Flow Turn On Type

Section 1320

SPECIFICATION DETAILS

504BDT ENGINE

Written In *Clear
And
Simple
English*

FRACTION to DECIMAL to MILLIMETER CONVERSION TABLE

Fraction	Decimal	MM	Fraction	Decimal	MM	Fraction	Decimal	MM
1/64	.0156	0.397	23/64	.3593	9.128	45/64	.7031	17.859
1/32	.0312	0.794	3/8	.3750	9.525	23/32	.7187	18.256
3/64	.0468	1.191	25/64	.3906	9.922	47/64	.7343	18.653
1/16	.0625	1.587	13/32	.4062	10.319	3/4	.7500	19.050
5/64	.0781	1.984	27/64	.4218	10.716	49/64	.7656	19.447
3/32	.0937	2.381	7/16	.4375	11.113	25/32	.7812	19.844
7/64	.1093	2.778	29/64	.4531	11.509	51/64	.7968	20.240
1/8	.1250	3.175	15/32	.4687	11.906	13/16	.8125	20.637
9/64	.1406	3.572	31/64	.4843	12.303	53/64	.8281	21.034
5/32	.1562	3.969	1/2	.5000	12.700	27/32	.8437	21.431
11/64	.1718	4.366	33/64	.5156	13.097	55/64	.8593	21.828
3/16	.1875	4.762	17/32	.5312	13.494	7/8	.8750	22.225
13/64	.2031	5.159	35/64	.5468	13.890	57/64	.8906	22.622
7/32	.2187	5.556	9/16	.5625	14.287	29/32	.9062	23.019
15/64	.2343	5.953	37/64	.5781	14.684	59/64	.9218	23.415
1/4	.2500	6.350	19/32	.5937	15.081	15/16	.9375	23.812
17/64	.2656	6.747	39/64	.6093	15.478	61/64	.9531	24.209
9/32	.2812	7.144	5/8	.6250	15.875	31/32	.9687	24.606
19/64	.2968	7.541	41/64	.6406	16.272	63/64	.9843	25.003
5/16	.3125	7.937	21/32	.6562	16.669	1	1.0000	25.400
21/64	.3281	8.334	43/64	.6718	17.065			
11/32	.3437	8.731	11/16	.6875	17.462			

INCH to MILLIMETER CONVERSION TABLE

Inch	MM	Inch	MM	Inch	MM	Inch	MM
1	25.400	6	152.000	10	254.000	60	1,524.000
2	50.800	7	177.800	20	508.000	70	1,778.000
3	76.200	8	203.200	30	762.000	80	2,032.000
4	101.600	9	228.600	40	1,016.000	90	2,286.000
5	127.000	10	254.000	50	1,270.000	100	2,540.000

TABLE OF CONTENTS

RUN-IN INSTRUCTIONS	3,4
ENGINE SPECIFICATION DETAILS	
Cylinder Sleeves	5
Piston	5
Piston Rings	5
Piston Pin	5
Connecting Rod	6
Crankshaft	6
Camshaft	7
Valve Push Rod Lifters	7
Gear Train	7
Oil Pump	8
Cylinder Head	8
Exhaust Valve	8
Intake Valve	9
Intake and Exhaust Valve Guides	9
Valve Spring	9
Rocker Arm Assembly	9
Intake Valve Timing	9
SPECIAL TORQUES	10, 11
GENERAL TORQUE SPECIFICATION TABLE	11

RUN-IN INSTRUCTIONS

Engine Lubrication

Fill the engine crankcase with CASE HDM oil and install new engine oil filters, after an engine has been rebuilt.

NOTE: Use a *SERIES 3 DS* or *CD SERVICE CLASSIFICATION* oil that has the correct viscosity rating for ambient air temperature, if CASE HDM oil is not used.

Change the engine oil while the engine is hot and replace the engine oil filters, after the first 20 hours of operation.

Change the engine oil and filters at the given intervals, after the 20 hours, as found in the Operator's Manual.

Run-In Procedure For Rebuilt Engines (With A Dynamometer)

The following procedure must be followed when using a PTO dynamometer to run-in the engine. The dynamometer will make sure of the control of the engine load at each speed and will remove stress on new parts during run-in.

During the run-in, continue to check the oil pressure, coolant level and coolant temperature.

STEP	TIME	ENGINE SPEED	DYNAMOMETER SCALE LOAD*
1	**10 Minutes	1000 RPM	Not Any
2	**10 Minutes	1800 RPM	Not Any
3	20 Minutes	1800 RPM	1/3
4	20 Minutes	1800 RPM	1/2
5	***30 Minutes	100 RPM below rated speed	3/4
6	Tighten the cylinder head bolts to the torque that is found in Section 2015 of the service manual.		

* According to normal dynamometer scale load at rated speed for the specific vehicle model. Decrease this scale load as shown.

** The best run-in procedure will constantly change the throttle between 750 to 1000 RPM, for the first 10 minutes and from 1000 to 1800 RPM, for the next 10 minutes. The purpose of this changing RPM is to change the lubrication and coolant flow.

*** 30 minutes at 3/4 load is a minimum amount of time the engine can be run. It is best that when possible, the engine (especially a turbocharged diesel) must be run for four (4) hours or more, at the above speed and load before checking the full engine horsepower or before using the engine for heavy field work.

Run-In Procedure For Rebuilt Engines (Without A Dynamometer)

STEP	TIME	ENGINE SPEED	LOAD
1	*10 Minutes	1000 RPM	Not Any
2	*10 Minutes	1800 RPM	Not Any
3	30 Minutes	2/3 Rated RPM	Light Load
4	1 Hour	Full RPM (not over 2000 RPM)	80 to 90%
5	Tighten the cylinder head bolts to the torque that is found in Section 2015 of the service manual.		

* If engine must then run at or near full load to operate the machine, remove the load for the first hour and run at high idle for several minutes at 15 minute intervals.

Run-In Procedure

Keep in one gear lower than normal for the first 8 hours of field operation. DO NOT "lug" the engine for the next 12 hours. Prevent "lugging" by moving the shift lever to a lower gear. The engine must not be "lugged" below the Rated Engine RPM during the early hours of life.

ENGINE SPECIFICATION DETAILS

Cylinder Sleeves

	U.S. Value	Metric Value
Type	Wet, Can Be Replaced	
Material	Cast Iron	
I.D. of Sleeve	4.6250 to 4.6263"	117.475 to 117.508 mm
Maximum Service Limit	4.6283"	117.559 mm
Sleeve Out of Round (Installed in Block)	0.002"	0.0508 mm
Maximum Service Limit	0.002"	0.0508 mm
Taper (Installed in Block)	0.001"	0.0254 mm
Maximum Service Limit	0.002"	0.051 mm
Clearance at Bottom of Piston,		
90 Degrees to Piston Pin	0.0052 to 0.0075"	0.1321 to 0.1905 mm
Maximum Service Limit	0.0100"	0.2540 mm

Piston

Type	Cam Ground	
Material	Aluminum Alloy	
O.D. At Bottom, 90 Degrees to Piston Pin	4.6188 to 4.6198"	117.3175 to 117.3429 mm
Minimum Service Limit	4.6178"	117.2921 mm
I.D. of Piston Pin Bore	1.6251 to 1.6253"	41.2775 to 41.2826 mm
Maximum Service Limit	1.6258"	41.295 mm
Width of 1st Ring Groove	Can Not Be Measured	
Width of 2nd Ring Groove	Can Not Be Measured	
Width of 3rd Ring Groove	0.188 to 0.189"	4.775 to 4.801 mm
Maximum Service Limit	0.1895"	4.813 mm

Piston Rings

Number One Compression (Top)	Keystone Type With Chrome Face	
End Gap in 4.625" (117.475 mm) I.D. Sleeve	0.015 to 0.025"	0.381 to 0.635 mm
Maximum Service Limit	0.030"	0.762 mm
Number Two Compression (Intermediate)	Keystone Type With Tapered Face	
End Gap in 4.625" (117.475 mm) I.D. Sleeve	0.013 to 0.023"	0.330 to 0.584 mm
Maximum Service Limit	0.030"	0.762 mm
Number Three Oil Control Ring (Bottom)	Two Piece	
Width	0.1860 to 0.1865"	4.7244 to 4.7371 mm
End Gap in 4.625" (117.475 mm) I.D. Sleeve	0.016 to 0.026"	0.406 to 0.660 mm
Maximum Service Limit	0.031"	0.787 mm
Side Clearance	0.0015 to 0.003"	0.038 to 0.076 mm
Maximum Service Limit	0.0035"	0.089 mm

Click on the image link below for the full version of the service manual

